

COMPONENT PART NOTICE

THIS PAPER IS A COMPONENT PART OF THE FOLLOWING COMPILATION REPORT:

(TITLE): Proceedings of the International Conference on the Performance
of Off-Road Vehicles and Machines (8th). Volume 3.
Held at Cambridge, England, on August 5-11, 1984

(SOURCE): _____

To ORDER THE COMPLETE COMPILATION REPORT USE AD A157 653.

THE COMPONENT PART IS PROVIDED HERE TO ALLOW USERS ACCESS TO INDIVIDUALLY AUTHORED SECTIONS OF PROCEEDINGS, ANNALS, SYMPOSIA, ETC. HOWEVER, THE COMPONENT SHOULD BE CONSIDERED WITHIN THE CONTEXT OF THE OVERALL COMPILATION REPORT AND NOT AS A STAND-ALONE TECHNICAL REPORT.

~~THE FOLLOWING COMPONENT PART NUMBERS COMPRISE THE COMPILATION REPORT:~~

AD# _____ TITLE: _____

Accession For	
NTIS GRA&I	<input checked="" type="checkbox"/>
DTIC TAB	<input type="checkbox"/>
Unannounced	<input type="checkbox"/>
Justification	
By	
Distribution/	
Availability Codes	
Dist	Avail and/or Special
A1	

This document has been approved for public release and sale; its distribution is unlimited.

1255

CENTRAL TIRE INFLATION SYSTEMS (CTIS) - A MEANS TO ENHANCE VEHICLE MOBILITY.

ROBERT W. KACZMAREK

US ARMY TANK-AUTOMOTIVE COMMAND, WARREN, MICHIGAN

For the vehicle designer there are numerous considerations that must be taken into account. Based upon the type of requirements which are to be placed upon a vehicle, a variety of alternatives are usually available to achieve the final design goal. The nature of modern warfare places an additional responsibility and somewhat more difficult burden on the designer of military wheeled vehicles.

Probably one of the most demanding features hoped for in modern military wheeled tactical vehicles is to achieve a high degree of mobility. If a wheeled vehicle is mobile it can function in a broader range of roles, therefore providing it with a higher degree of utility.

Since there are numerous ways of increasing a wheeled vehicles overall mobility and effectiveness it then becomes a choice of which mobility features to incorporate into a vehicle design and how effective each of these features are from a performance and a cost effectiveness standpoint.

One of the most effective and well proven systems that has been adapted to wheeled tactical vehicles to improve the overall vehicle mobility is CTIS. In general these systems, feature relatively simple designs, are a highly effective and convenient method of enhancing vehicle mobility and are relatively simple to operate.

The intent of this paper is to discuss the issue of CTIS from the advent of the technology to the state-of-the art.

A CTIS can be defined as, "A system incorporated in a wheeled vehicle which permits the vehicle tire pressures to be regulated by the vehicle driver/crew member from within the vehicle cab while on the move". If the vehicle tires are deflated from 50psi to 15psi the tire footprints will increase substantially. Whenever the area of the footprint is increased the ground pressure which that vehicle experiences is reduced. Assuming that the soil strength conditions are identical, the tractive effort and overall mobility for a vehicle will increase at the lower pressure level, hence allowing this vehicle to accomplish a high level of mobility performance.

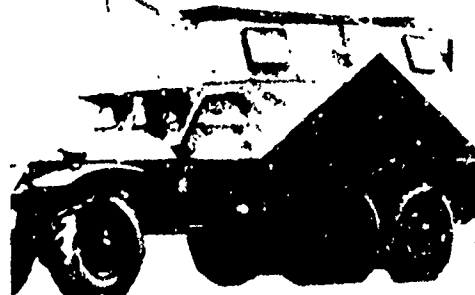

Fig. 1 BTR-152 Soviet Armored Car

AD-P004 399

1256

The BTR-152 Soviet Armored Car (Fig. 1) utilized CTIS. The CTIS design for the BTR-152 was of the "Pentagraph" type which had exposed air lines that led to the wheel hubs. On the overall, the CTIS operation on the BTR-152 did improve overall vehicle mobility; however when the vehicle negotiated rough terrain or heavy vegetation the "Pentagraph" lines were damaged and adversely effected the operation of the CTIS. Fig. 2 basically illustrates the system layout for the CTIS which the BTR-152 vehicle employed.

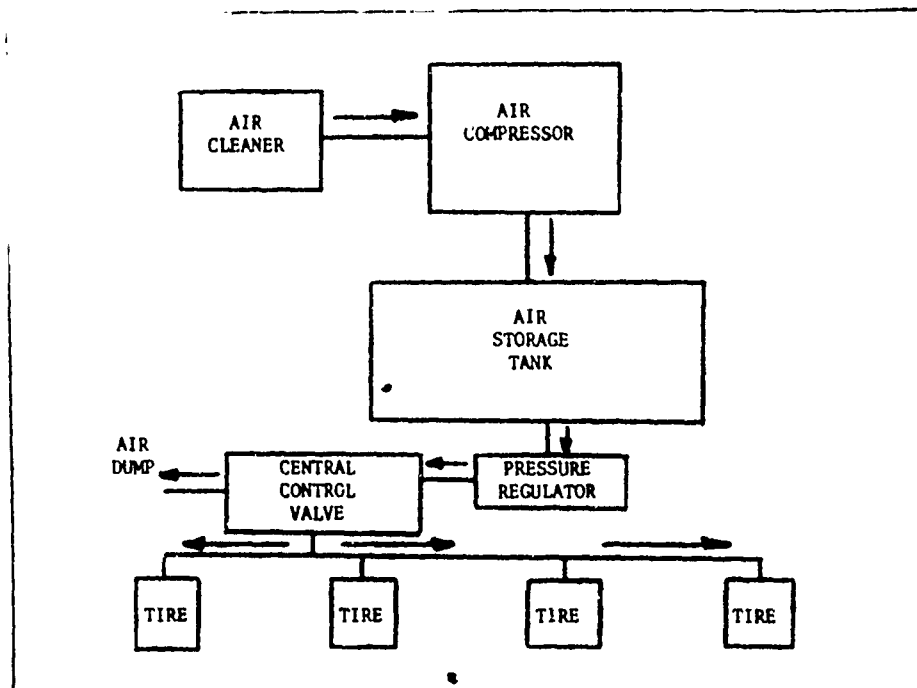

Fig. 2 BTR-152 CTIS System

The operation of this system was very simple. As shown in figure 2, air entered the system thru an air cleaner, was compressed into an air storage tank and regulated at a pre-set working system pressure. When it was desired to increase tire pressure levels the inflation control valve was positioned in the inflate mode and the vehicle tires were inflated, when deflation was desired the vehicle operator simply positioned the control valve to the deflation position, permitting the tires to "dump" air past the control valve.

After World War II both the United States and the Soviet Union experimented with CTIS to include utilizing slip rings on the axles as a means of transferring air from the drilled axles to the vehicle tires. (Fig. 3) illustrates a typical slip ring assembly and its relationship to the vehicle axle housing.

1257

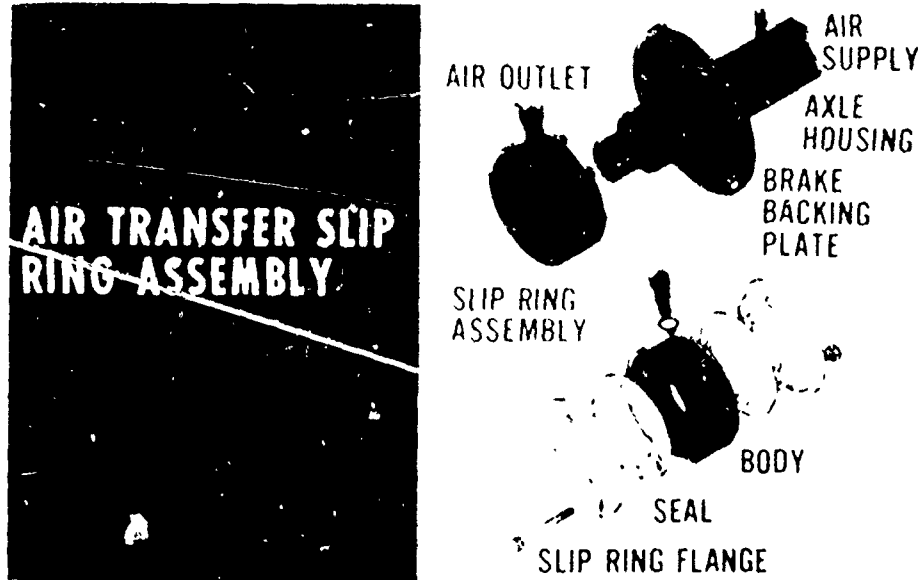

Fig. 3 Air Transfer Slip Ring Assembly

Since World War II the Soviet Union and Warsaw Pact Countries have emphasized the use of CTIS on all tactical wheeled vehicles. Fig. 4 is a diagram of a CTIS System utilized on an early Soviet 2½ tonne cargo truck (ZIL-157). The ZIL-157 was a departure from the earlier vehicles utilizing CTIS in that it did employ slip rings on the axles as a means of air delivery. Each slip ring assembly is fitted with seals to help prevent air leakage. By observing Fig. 4 it is evident that the basic difference between the CTIS on the BTR-152 and the ZIL-157 is the utilization of the slip ring.

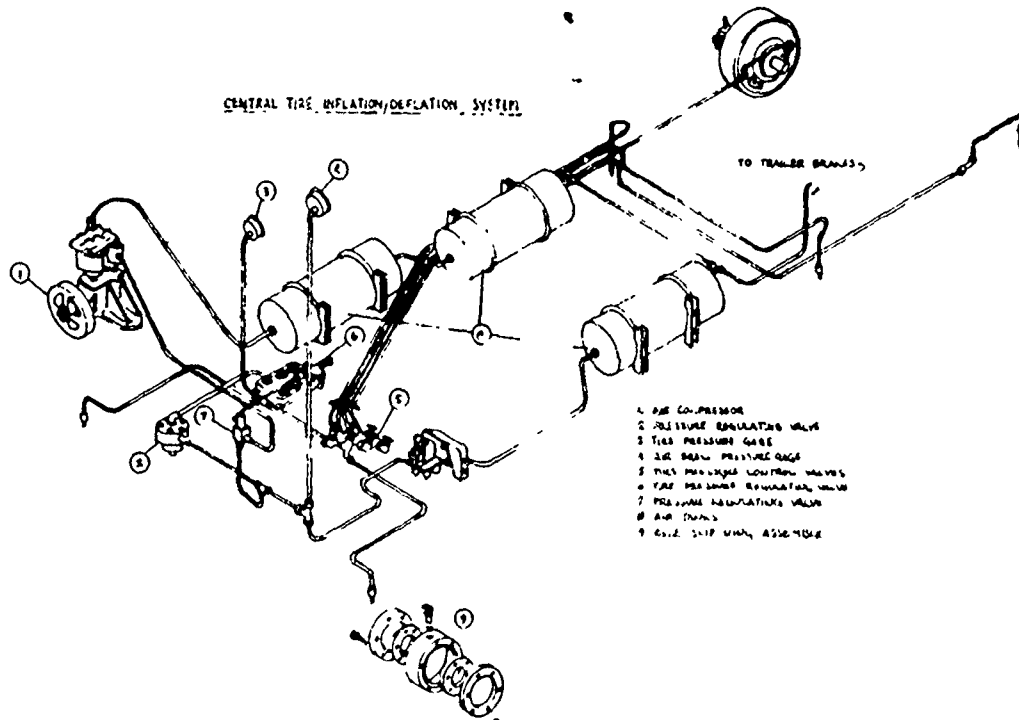

Fig. 4 ZIL-157 CTIS System

Since CTIS is usually installed on vehicles which have an air brake system, the air pressure for CTIS and air brake operations is supplied from a common vehicle air tank supply system. Being that vehicle safety is more important than vehicle performance a valve is installed on the vehicle air tank supply system which assures that the air pressure required to operate the vehicle air brakes is satisfactory prior to diverting air pressure to operate CTIS. If the vehicle air tank supply pressure level is relatively low, this valve will regulate air pressure to the air brakes for operation but no air pressure will be delivered for CTIS usage.

It was emphasized earlier in this paper that the primary intent of CTIS from a mobility standpoint is to lower vehicle tire pressure levels in an effort to increase the tire ground contact area which will lower the overall ground pressure and help increase vehicle drawbar pull and mobility. Figure 5 is a graph of the changes in tire footprint areas for the ZIL-157 vehicle utilizing a 12:00 X 18 bias ply aggressive tread tire. Both the net and gross footprint areas more than double when the tire pressures are dropped from 50psi to 10psi. This footprint area increases primarily in the length dimension.

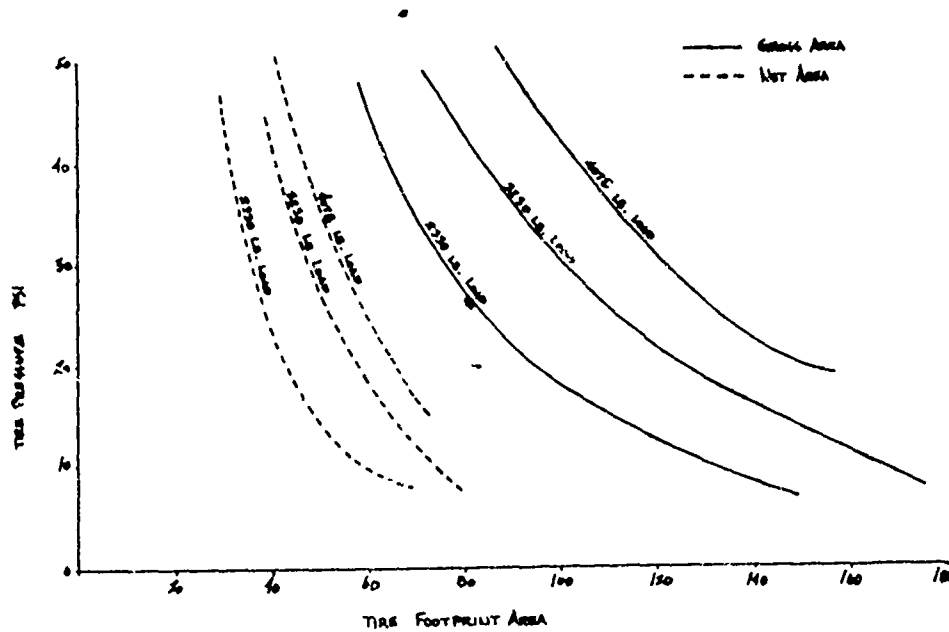

Fig. 5 ZIL-157 Footprint Areas

Figure 6 is a table which illustrates the maximum increase in Drawbar-Pull while reducing inflation pressure levels on the ZIL-157 vehicle. It is interesting to note the percent increase in drawbar-pull when tire pressure levels are reduced.

Tires used on vehicles utilizing CTIS can be standard type tires, bias or radial ply, tube or tubeless design. If a tube is used within the tire, the valve core must be removed to allow for deflation of the tire when the CTIS control valve is activated from within the vehicle cab.

The wheels that are used for CTIS design are of the "split" type configuration to allow for a bead spreader to be installed within the tire. A bead spreader must be used to compress the tire bead against the inner wheel rim surface so that when operating at low tire pressures the tire bead does not separate from the inner wheel rim and deflate the vehicle tires. A locking device is also installed in the tire/wheel assembly to prevent the tube from rotating in relation to the wheel at low tire pressures. Figure 7 illustrates the tire/wheel assembly with bead spreader which is employed on the TATRA 813 vehicle.

SOIL	VEHICLE	INFLATION PRESSURE psi	DRAWBAR PULL lbs.	DRAWBAR PULL INCREASE %
WET LOAM	ZIL-157	35	3600	- -
		15	4300	19 -
		7	5000	39 16
FINE SAND	ZIL-157	35	5000	-
		15	6300	26
COURSE SAND	ZIL-157	35	3000	-
		15	5000	66
DRY LOAM	ZIL-157	35	8500	-
		15	9200	8

Fig. 6 ZIL-157 Drawbar Pull At Varying Tire Pressures

The Czechoslovakian TATRA 813, 8X8, 8 tonne Tactical Cargo Truck (Fig. 8) produced in the 1965 timeframe, utilizes CTIS. The configuration of the CTIS inflation/deflation controls and the manifold for the tire pressure control valves on the TATRA 813 vehicle are an improved design but the overall system functions in basically the same manner as earlier systems (Fig. 9)

1260

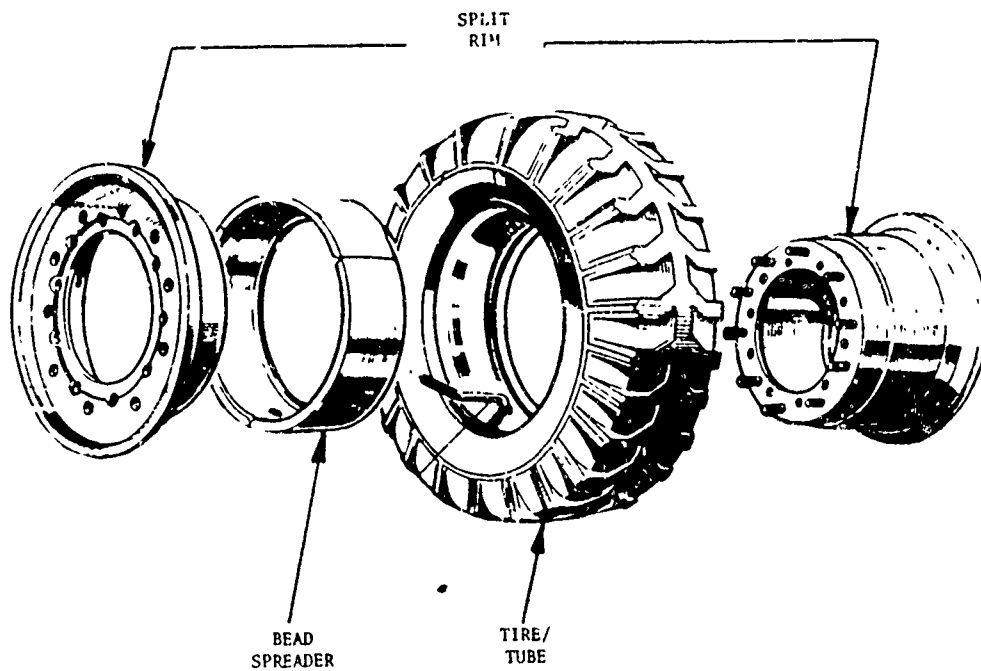

Fig. 7 TATRA 813 Tire/Wheel Assembly



Fig. 8 TATRA 813 Vehicle

1261

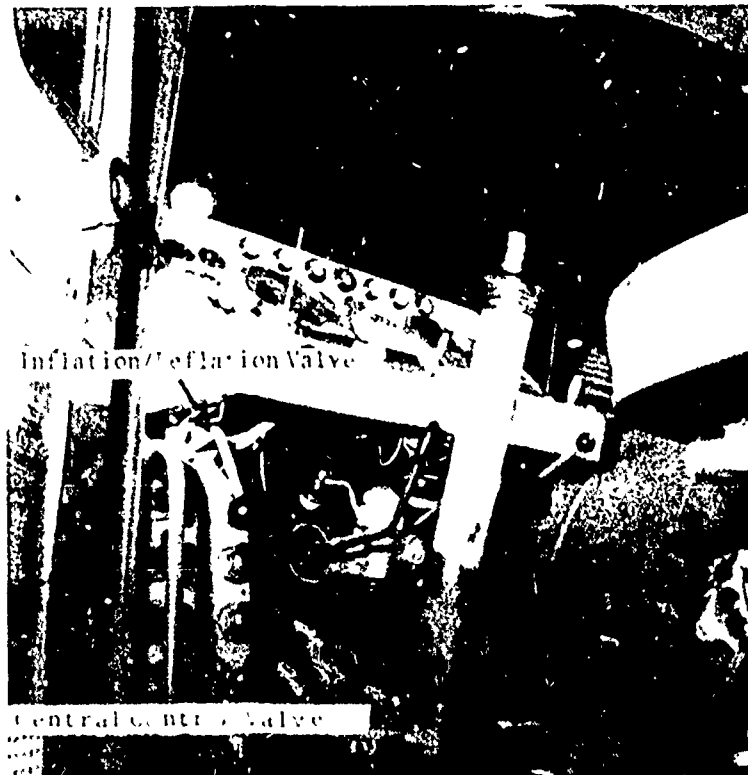

Fig 9 TATRA 813 CTIS Controls

The Yugoslavian FAP 2026, 6X6, 6 tonne Tactical Truck (Fig. 10) produced in the 1977 timeframe, also utilizes CTIS. In the authors opinion, the FAP 2026 CTIS control console represents a clear departure in design from other Soviet/Warsaw Pact vehicle systems. On previously known vehicles of this type, there were central manifolds designed into the system which allowed for isolating leaks or "blown out" vehicle tires by the use of valving from within the vehicle cab. Some systems allowed the vehicle operator to monitor the pressure of an individual tire or the entire CTIS from within the cab. On the FAP 2026 vehicle (Fig. 11) the only two controls are the control for activating/deactivating the CTIS, and the pressure control valve which allows the driver/operator to pre-select the vehicle tire pressures according to the terrain which the vehicle will be subjected to. The graduations on the pressure control are labeled in bars of pressure.

Judging from the known employment of CTIS on tactical vehicles it is apparent that since World War II the Soviet Union & Warsaw Pact countries have dominated this technology area. However, in recent years the emphasis on ways to increase a vehicles overall mobility has re-surfaced the issue of CTIS in the free world.

1262



Fig. 10 FAP 2026 Vehicle

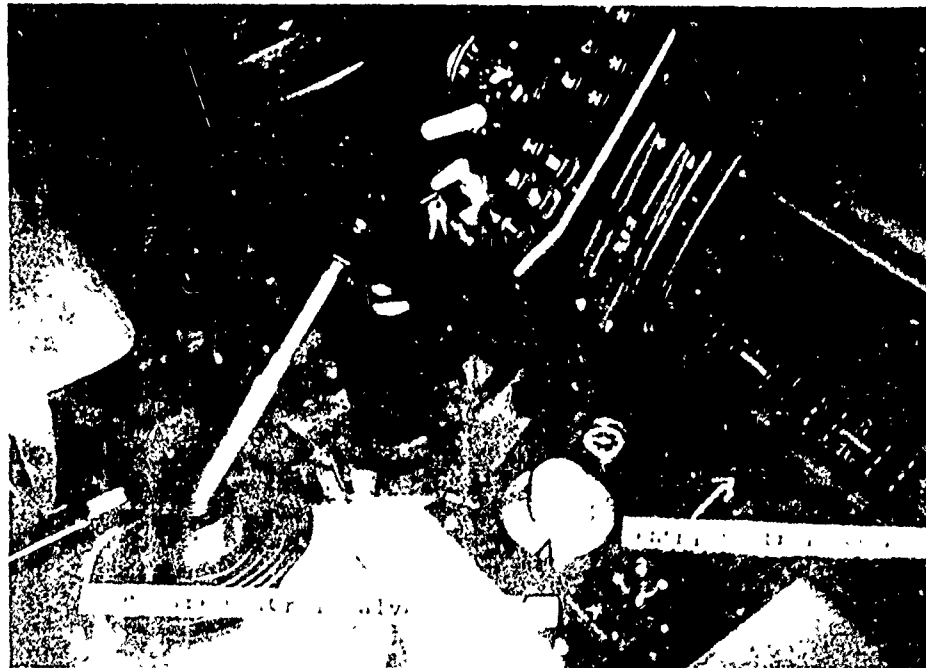

Fig. 11 FAP 2026 CTIS Controls

A system which is currently being marketed by the AM General Corporation is adapted to a five ton tactical truck (Fig. 12) and is fitted with radial ply tires. All previously known applications of CTIS have utilized bias ply tires, so the change to a radial tire certainly should add a dimension to enhancing a vehicles overall mobility. Fig. 13 illustrates the general layout of the CTIS utilized by AM General Corporation.

1263

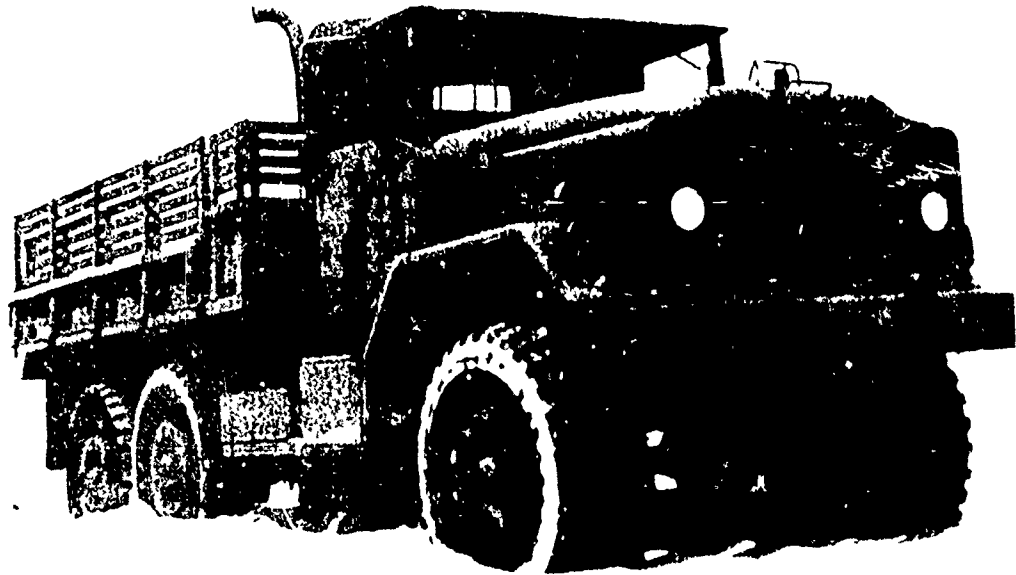

Fig. 12 AM General 5 Ton Cargo Truck

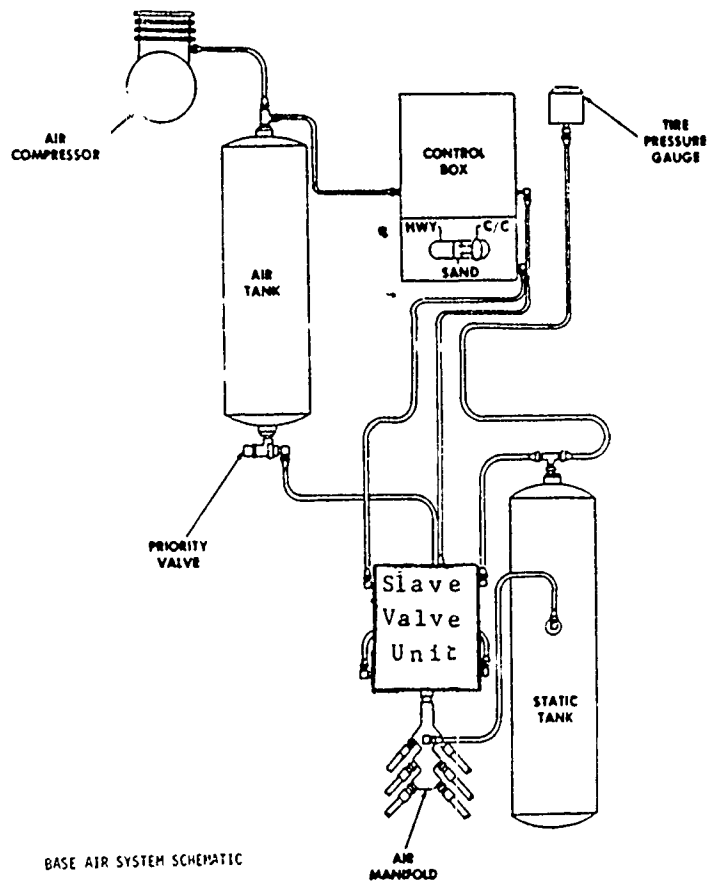

Fig. 13 AM General CTIS System

The design of AM Generals patented system incorporates some definite improvements to previously known systems. In an effort to reduce tire inflation times a large 16.1 CFM air compressor is used. For comparative purposes the ZIL-157, an earlier Soviet 6X6 vehicle utilized a 5.5 CFM air compressor. The AM General system incorporates a single air tank (for air brakes and CTIS) instead of two or three interconnected tanks as observed in earlier generation system designs. A straight forward and simple to use pressure control valve is also utilized on the AM General design for the various terrains which a vehicle may have to negotiate.

In the authors opinion, the AM General CTIS design represents the state-of-the-art- in the CTIS technology area. Nevertheless, there are other technical approaches worth mentioning which could have merit in varying vehicle tire pressure levels as a means to increase overall vehicle mobility.

Currently there are R&D efforts underway to design and manufacture charged cartridges that can be adapted to a vehicle axle hub with hose connection between the charged cylinder and the vehicle tire. An electronic signal from the vehicle driver/operator activates a valve on the charged cylinder for inflating/deflating a vehicle tire. This system would eliminate the need for a vehicle compressor and the associated controls and plumbing but would be limited from the standpoint of the number of times it could inflate a vehicle tire prior to being re-charged or exchanged for a new cylinder. In a combat environment the charging of these cylinders could also prove to be hazardous.

Due to the characteristically strong flexible sidewall of a radial ply tire, the quality of the vehicle ride and handling are substantially better than that of a vehicle utilizing conventional bias ply tires. In the past several years an extensive amount of progress has been made on advanced radial tire designs. It would be ideal to assume that a radial tire could be designed to operate at one standard pressure level for both soft soil and primary road application. Such a design would allow a vehicle to have low ground pressure and high traction in the off road terrain and then be able to operate at high speeds on primary roads with relatively low rolling resistance to prevent high heat build-up. Some current tire designs have been offered as candidates for use as a standard pressure tire but to date have not received overall approval for this type of usage. In the event that a currently produced larger size radial tire were used to fulfill this requirement it would probably prove to be too heavy for the application. As a result vehicle ride and handling would be degraded and the tires would probably have a tendency to over-heat during high speed driving on primary roads, hence destroying the tire.

It is also reasonable to assume that a completely unique automatic CTIS could be designed which would require no driver/operator input or judgment. Such a system would automatically sense and continually monitor the terrain conditions and adjust the vehicle tire pressures to an optimum pressure level. In addition, such a system could activate/deactivate the vehicles differential locking mechanisms on an "as needed" basis; depending on the terrain being negotiated.

Up to this point various CTI systems have been discussed with an attempt to generally describe what type of hardware has been developed as well as introducing some alternative approaches to increasing vehicle mobility by varying tire pressure/profile relationships.

If a component is to be designed into a vehicle configuration, regardless if it concerns the vehicles mobility, survivability or maintainability; it must focus around the original intent or mission of the vehicle itself. Depending on how well these components are chosen and engineered into the vehicle design is somewhat dependent upon how successful the vehicle will fulfill this mission.

Webster's Dictionary defines a mission as "an assigned duty or task". This definition can be exemplified upon when we attempt to define the mission of a vehicle. A very general definition of the mission of a wheeled cargo truck could be "to transport personnel and equipment over various terrains in an effective manner". Hence, when designing such a vehicle it would seem practical to place the most concern on those factors or components which would provide the vehicle with the highest probability of completing its intended purpose. Such a vehicle must possess certain engineering performance characteristics or potentials (i.e. specific acceleration, top speed, grade climbing) in order to negotiate the obstacles throughout the vehicle mission. The vehicle should be designed to a high degree of reliability so that failures are kept to a minimum so as not to interfere with mission completion. Last but not least, time required to fulfill a mission must be taken into consideration.

The performance characteristics of a vehicle must always be highly regarded during a vehicle design phase. Certifications concerning engine horsepower, vehicle step climbing capability, minimum braking distance, soft soil mobility performance, etc. are all somewhat common requirements for modern military wheeled vehicles.

Whenever CTIS is considered for adaptation to a wheeled vehicle it is probably viewed as a system which enhances a vehicles mobility performance. However, it should also be noted that by utilizing CTIS, the ride and handling characteristics of the vehicle can also be improved, therefore labeling it as an impressive side benefit. The more energy that is absorbed by a vehicle operator or the vehicle components, the more fatigue occurs, causing overall degraded vehicle performance and eventual component failures.

1266

A CTIS was adapted to some 15 and 16 ton US Goer Vehicles (Fig. 14). Since the Goer vehicles did not have a suspension system, the flexing of the sidewalls of the large 16 ply, 29.5 X 25.00 earthmover type tires provided the only means of absorbing the shock between the terrain and the vehicle. In a tactical truck, if the tire design is properly chosen, it too will reduce shock and have a cushioning effect upon the vehicle driver and the suspension components.



Fig. 14 US Goer Vehicle (16 Ton)

On a vehicle that employs CTIS the tire pressure levels can be adjusted when negotiating rough terrain. The lowering of the tire pressures will then allow greater flexing in the tire sidewall which will decrease the amount of energy normally experienced in the vehicle suspension system components thereby increasing component life and improving the overall reliability and maintainability of the vehicle.

Fig. 15 graphically displays the relationship between surface roughness/vehicle tire pressures at various vehicle speeds.

1267

If CTIS is properly utilized and consequently does improve the overall reliability and maintainability of a vehicle then it can prove to be a very cost effective system. Fig. 16 graphically displays the relationship between maintenance costs and usage of vehicles over various surface roughness courses.

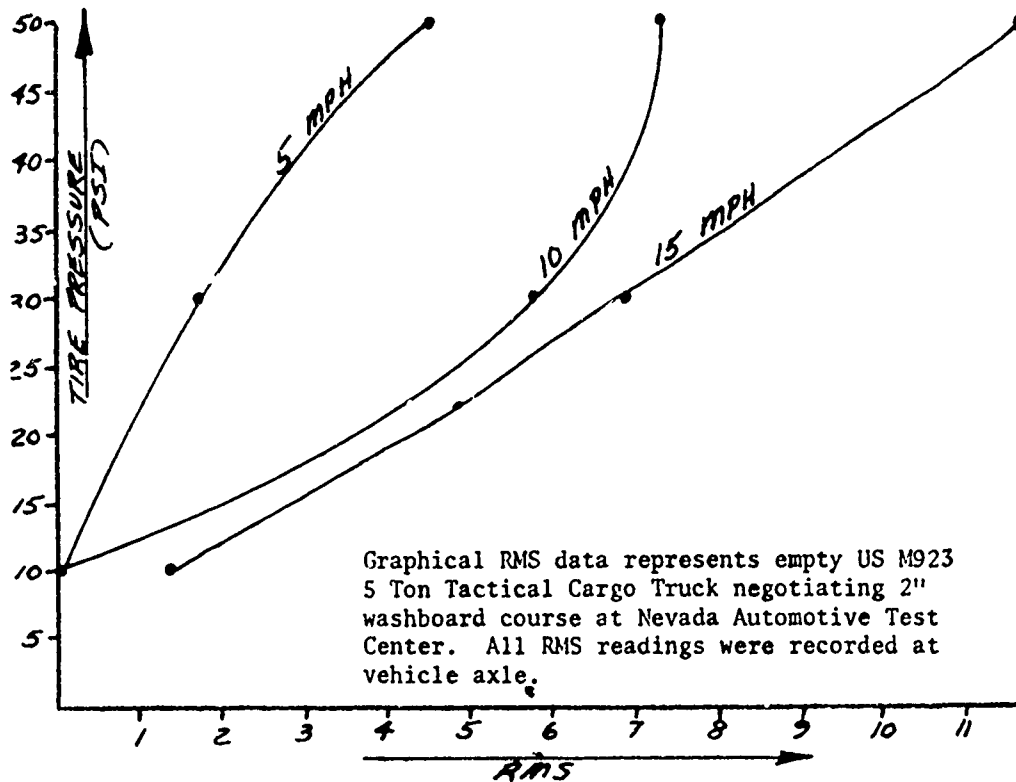
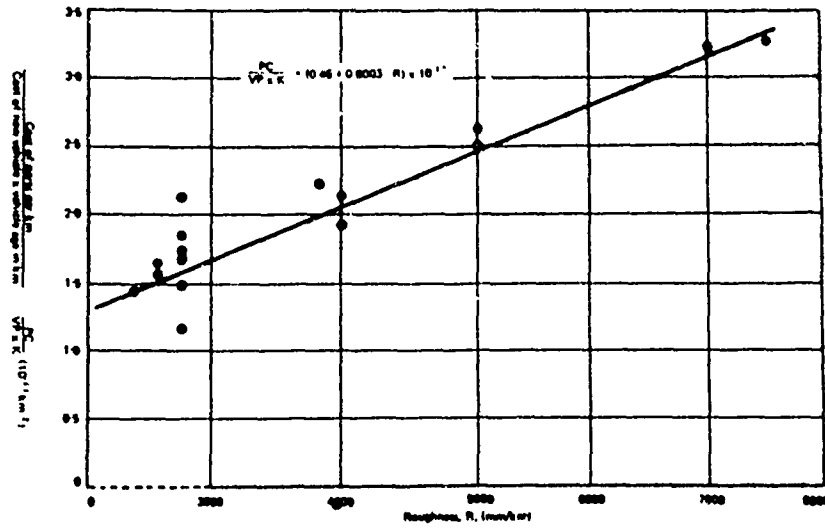

Fig. 15 Surface Roughness Vehicle Tire Pressures At Various Vehicle Speeds

Utilization of CTIS can also have a positive impact from the Human Engineering/Psychological viewpoint. If a vehicle driver has been operating a vehicle which has a somewhat rough ride, this driver will experience most of the accelerations/decelerations when the vehicle is negotiating rough terrain. Driving a vehicle under these conditions will increase driver fatigue and will most likely also increase the time required to negotiate a given terrain. From a psychological viewpoint, an operator will become disgruntled with a vehicle that has a marginal performance level. A driver needs to have confidence in the equipment he/she is operating or the level of accomplishment will be relatively low.

In general, whenever the time element to complete a given task can be reduced, the more efficient an operation becomes. Likewise whenever we increase the time it takes to complete a given mission, the overall effectiveness of that mission decrease accordingly.

1268



THE RELATIONSHIP BETWEEN PARTS CONSUMPTION, VEHICLE AGE IN KILOMETRES, AND ROAD SURFACE ROUGHNESS FOR MEDIUM AND HEAVY GOODS VEHICLES

(Reproduced from British Department of Transport, Transport Road and Research Laboratory Report 672. The Kenya Road Transport Cost Study: Research Vehicle Operating Costs)

Fig. 16 Vehicle Maintenance Cost/Terrain Surface Roughness

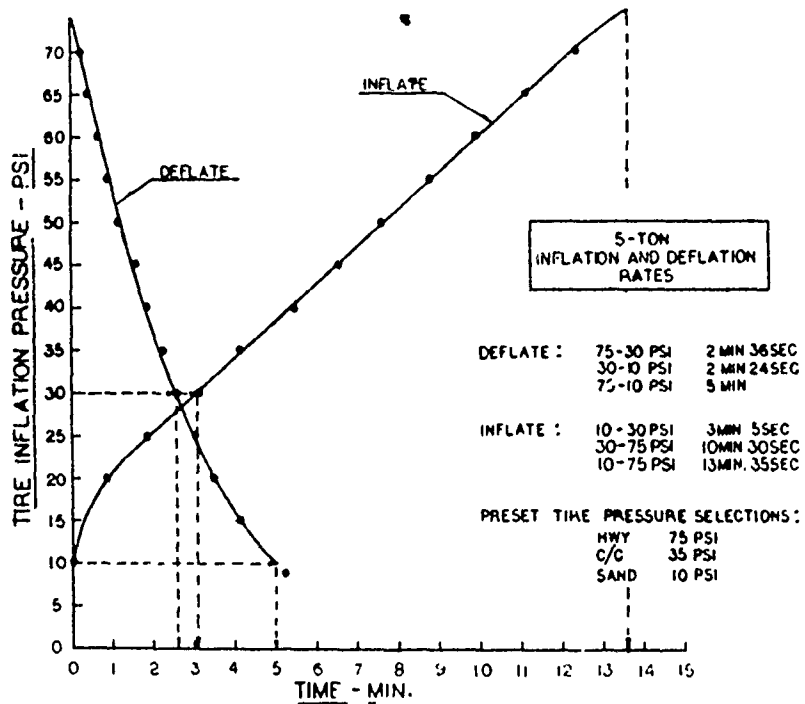

Fig. 17 Inflation/Deflation Times For AM General CTIS

Since the time factor can be such an important element when viewing a vehicle mission, it would seem practical and cost effective to incorporate those features/components into the overall vehicle design package which will help minimize the elapsed mission time.

Assuming that we have two identical wheeled vehicles, one with CTIS and one without; in all probability the vehicle equipped with CTIS will function in a more effective manner.

From the standpoint of negotiating adverse terrain the vehicle with CTIS will adapt to a given situation (varying tire pressure levels) in a quicker, more organized manner than the vehicle without CTIS. A vehicle with CTIS can have the tire pressures altered from within the vehicle cab while on the move. A vehicle without CTIS must first be stopped and the crew must physically exit the cab and manually inflate/deflate each vehicle tire. Depending on the type of CTIS employed the tire inflation/deflation times may vary but on the overall it takes considerably longer for a vehicle without CTIS to have tire pressures adjusted manually to the same pressure level of a vehicle utilizing CTIS.

Fig. 17 is a graphical display of the times recorded to inflate/deflate the AM General CTIS utilizing the Michelin 14.00 X 20 XS tires.

Since the tire size (volume) and number of tires on a vehicle (drive mode) are directly related to inflation/deflation times, the air compressor capacity is a critical factor. Hence, the best ways of decreasing inflation times is to increase the air compressor capacity and have it operating at optimum RPM. Likewise, the most logical means of decreasing tire deflation times is to provide for larger air exhaust ports and associated plumbing.

In a combat environment vehicle tires can be very vulnerable. If a vehicle employs CTIS the probability of completing missions in a timely manner and increasing a vehicles survivability is enhanced. Depending on the system design various corrective procedures can be followed for a punctured or blown out tire. On some of the Soviet/Warsaw Pact designs the wheel which has a leaking tire is isolated from the overall system by closing of a valve within the cab. Most systems also employ valves at the vehicle wheel which can be physically turned off in the event of puncture or leakage. Another approach could be to utilize a larger size air compressor which could accomodate a considerable amount of leakage.

The following is the authors opinion of some of the necessary general characteristics for an ideal CTIS.

a. In order to provide air pressure for both the vehicles air brakes and CTIS an adequately sized air compressor should be fitted into the design package. Such a compressor would account for inflating vehicle tires from minimum to maximum pressures in a relatively short timeframe as well as providing for an occasional leakage or blown out tire.

b. The CTIS cab controls should incorporate a straight forward and simple design and be convenient for the vehicle driver to operate. Such features as a range of positions to place the tire pressure control lever, depending on the terrain that is to be negotiated (i.e. mud, gravel, paved highway, etc.) can help reduce driver confusion and error and enhance overall mission effectiveness.

c. A well designed CTIS will incorporate a high degree of safety. From the standpoint of adequate vehicle air brake pressure, proper valving should be fitted to the vehicle air tank system to assure that the air brakes have priority over CTIS.

d. Because of the obvious advantages radial ply tires have over bias ply tires regarding vehicle ride, handling & overall performance it would seem logical to fit a vehicle utilizing CTIS with radial ply tires. Fig. 18 illustrates the footprint areas of both the standard US NDCC and the newer Michelin XS tires at varying pressure levels.

COMPARISON OF TIRE GROUND CONTACT AREA

GOODYEAR 11:00 - 20 NDCC, DUALS VS. MICHELIN 14:00-R20 XS SINGLES

NDCC

HIGHWAY



127 SQ IN

CROSS COUNTRY



153 SQ IN

MUD SAND - SNOW



166 SQ IN

MICHELIN XS

HIGHWAY



100 SQ IN.

CROSS COUNTRY



195 SQ IN

MUD - SAND - SNOW



360 SQ IN

Fig. 18 NDCC/Michelin Tire Footprint Areas

1271

SUMMARY & CONCLUSIONS

The modern day pneumatic tire is designed to fulfill a broad range of requirements for numerous vehicle applications. Due to the characteristics of tire sidewall flexibility, vehicle designers are capable of employing CTIS on a vehicle to enhance its mobility and ride dynamics. By deflating the tires on a vehicle, the tire sidewall flexibility functions as a shock and vibration damper for the vehicle over rough terrain. In effect, by using CTIS, the vehicle suspension system can be optimally tuned for a broad range of terrain conditions. The installation and proper usage of CTIS can therefore optimize a vehicles overall tractive-dynamic performance, allowing a vehicles power parameters to be utilized in the most practical and cost effective manner.

ACKNOWLEDGMENTS

The author would like to express appreciation to the following organization for the use of technical information applicable to this paper:

US Army Tank Automotive Command
US Army Foreign Science and Technology Center
AM General Corporation
Nevada Automotive Test Center